

High-speed spiral doors

When speed is of the essence

S Series

TOR18



EFAFLEX 
safe high-speed doors



S Series

The S Series high-speed spiral doors from EFAFLEX give you a leading edge when speed is of the essence. Thanks to the unique design of the EFAFLEX spirals, our spiral doors achieve top speeds of up to 4 m/s. Therefore, they don't just accelerate your work processes many times over, they save energy at the same time thanks to their rapid opening and closing speeds. Customers all over the world value the high-speed spiral doors from EFAFLEX for their outstanding quality, maximum levels of security and superb durability.



The spiral. Often imitated – but unrivalled to this day.

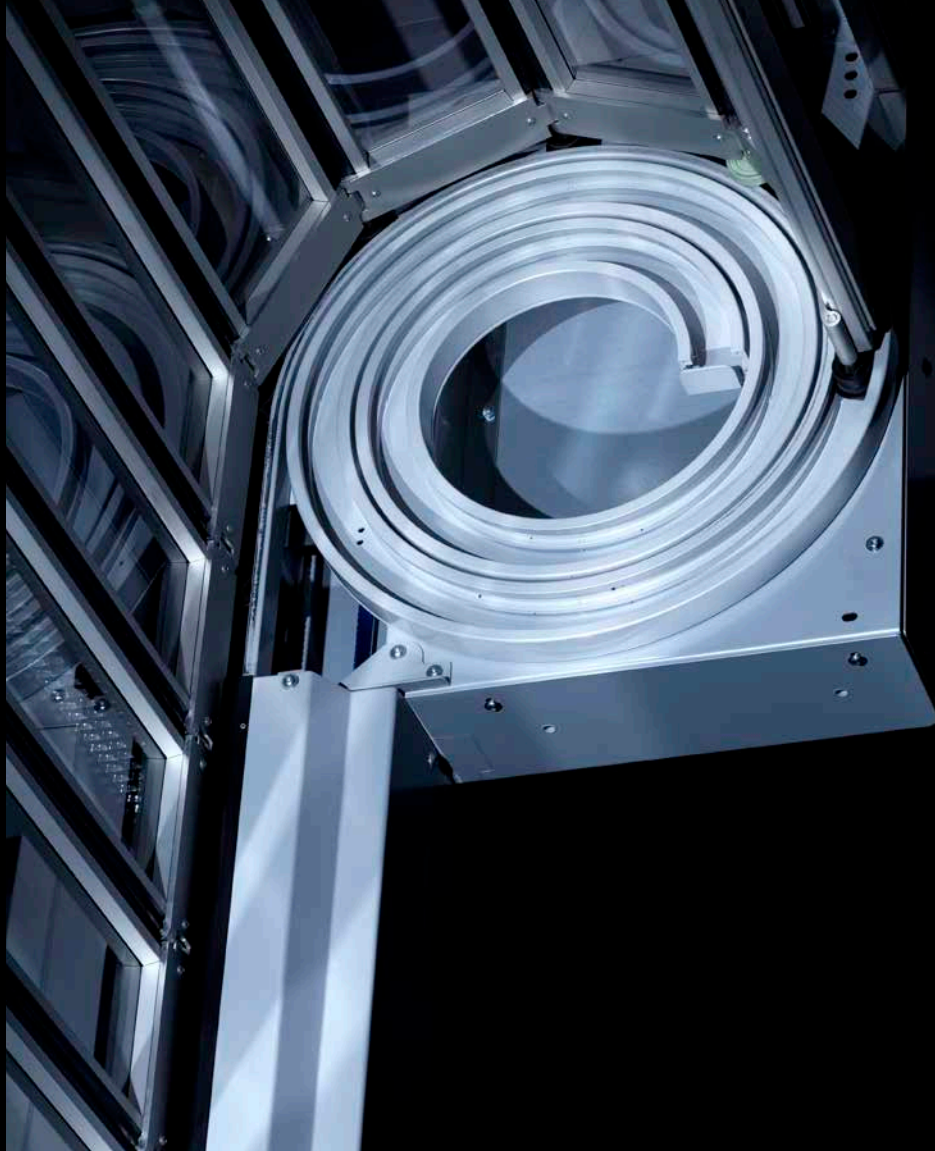

It was more than 25 years ago that EFAFLEX invented the spiral door, and since then we have continued to develop and improve it as a leading innovator. The EFAFLEX spiral represents perfection in door leaf guides: the door leaf is not wound on a shaft, but rather kept at a space-saving distance by the spiral-shaped guiding system. Thanks to this mechanical principle, spiral doors from EFAFLEX are exceptionally quiet, almost wear-free and extremely fast.

The spiral door technology from EFAFLEX is unrivalled to this day and remains a global example for outstanding door technology. No other design is able to combine the highest opening speeds, durability and effectiveness so well. Our high-speed spiral doors are also available in a wide range of designs and can be installed where space is limited.

A range of spiral door technologies.

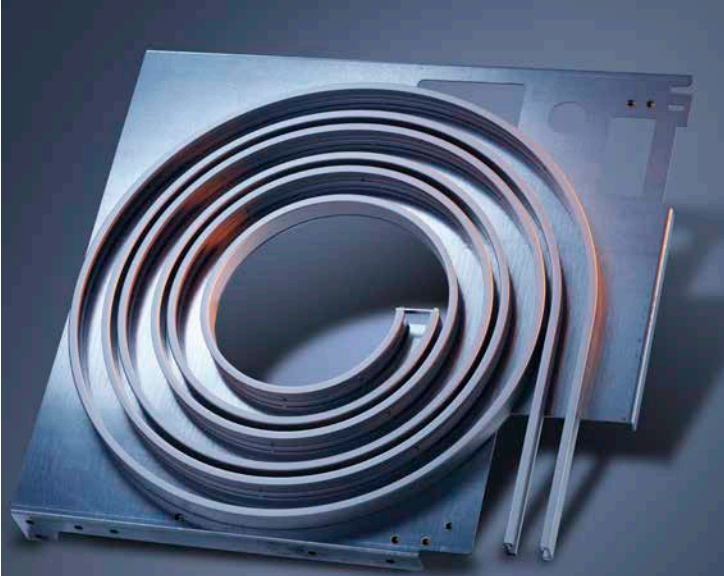

IN ROUND SPIRAL, OVAL SPIRAL AND LOW-HEADER VERSION

Our high-speed spiral doors come standard with the circular round spiral, which is the best solution for the fastest opening and closing times. If the space above the door is limited, you can also choose between two space-saving variants for many door types in the S Series: oval spiral and low header.

**ALL VERSIONS
GUARANTEE MAXIMUM
SAFETY FOR PEOPLE AND
VEHICLES!**

ROUND SPIRAL

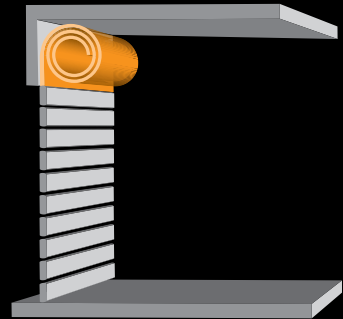

The round spiral is standard and the ideal solution when you have sufficient space above the door.

OVAL SPIRAL

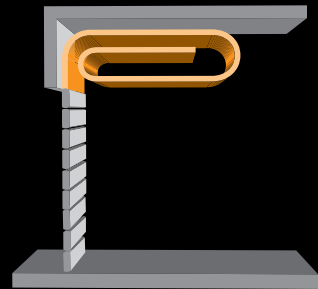

Oval and thus space-saving designs are used in case of restricted structural conditions.

LOW HEADER

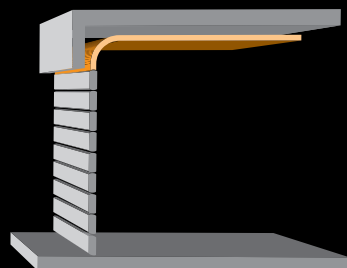

For example, the low-header version is useful in underground and multi-storey car parks.



EFA-SST®
AT A GLANCE:

- Max. heat insulation with EFA-THERM® laths
- Opening speed up to 2.5 m/s
- Closing speed up to 1.0 m/s
- Highest wind load capacity
- Top safety devices
- Up to 250,000 operating cycles p.a.
- Standard sizes up to w=10,000 mm, h=12,000 mm

Spiral door technology in perfection.

EFA-SST®

The EFA-SST® high-speed spiral door represents a new, more modern generation of industrial doors: perfect insulation, energy-efficient functionality, state-of-the-art technology. During the technical redesign, particular attention was paid to improving the physical properties of the door leaf as well as optimising the functionality, thus once again raising the standard of EFAFLEX industrial doors.

THE ORIGINAL AMONG THE SPIRAL DOORS

The EFA-SST® is the classic EFAFLEX high-speed door and is our most successful range. We have developed three standard versions to meet your highly varied requirements for high-speed doors.

EFA-SST® PREMIUM

Designed for continuous industrial use, this version effortlessly handles up to 250,000 load cycles per year. The opening speed is up to 2.5 m/s. The scope of delivery includes a burglar-proof locking mechanism and the TÜV-tested EFA-TLG® safety system.

EFA-SST® ECO

With up to 200,000 cycles per year, the load capacity of the EFA-SST® ECO is well above average. This EFA-SST® version is characterised by sturdy construction and the usual EFAFLEX reliability combined with opening speeds of approx. 1.5 m/s.

EFA-SST® BASIC

With 150,000 opening and closing cycles per year, the EFA-SST® Basic is the perfect entry-level version to discover the high EFAFLEX quality first-hand.



VERSATILE DOOR LEAF

The door leaf for the EFAFLEX industrial door is extraordinarily robust, tight and sound-insulating. You can determine the required number of EFA-CLEAR® transparent laths for your EFA-SST® according to how much light you want to come through. The EFAFLEX spiral does not wind the door leaf onto a shaft, but rather keeps it at a distance to save space. This optimal design combines the highest opening speeds, durability and effectiveness.

CUTTING-EDGE INSULATION

As the first manufacturer of industrial doors worldwide, EFAFLEX offers thermally separated EFA-THERM® insulation laths for the EFA-SST® as a standard. Depending on the door size, this allows for outstanding thermal insulation values of between 0.66 and 1.52 W/m²K to be achieved. Thanks to the fast opening and closing speeds of our industrial high-speed doors, little energy is lost to the outside or between two rooms.

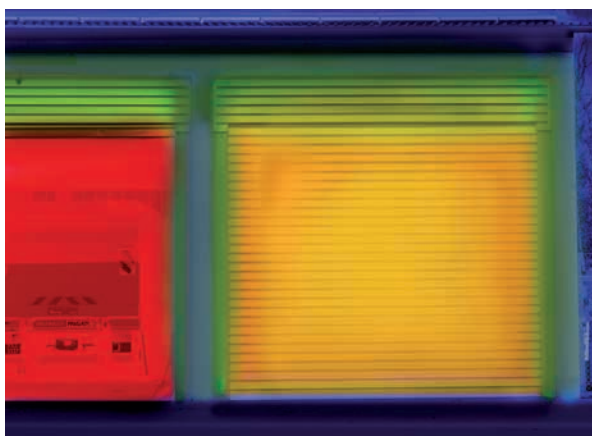

This thermal image of an ordinary roll-up door clearly shows the large heat loss to the outside.

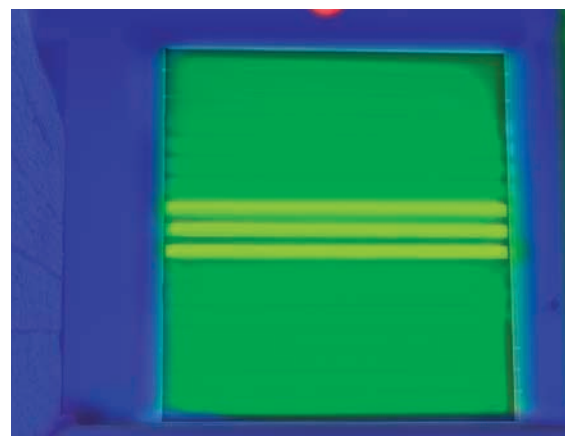
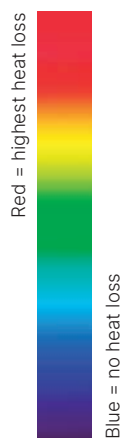

The thermally separated EFA-THERM® laths of the EFA-SST® considerably improve the thermal insulation and thus reduce energy costs.



**EFA-SST® ESSENTIAL
AT A GLANCE:**

- Excellent acoustic and thermal insulation
- Wind resistance class 2 – 4
- Up to 100,000 load cycles p.a.
- Suitable for external and internal applications
- Opening speed up to 0.5 m/s
- Standard sizes up to w=4,500 mm, h=5,000 mm

The entry-level door with best price-performance.

EFA-SST® Essential

Powerful, robust, economical: An attractive purchase price combined with EFAFLEX's consistently high quality standards make the EFA-SST® Essential high-speed spiral door the price-performance champion. The homogeneous design of the spiral guarantees very smooth running while also maintaining high speeds of up to 0.5 m/s.



ENERGY-EFFICIENT SOUND AND THERMAL INSULATION

Rising energy prices and increasingly unstable raw material supply chains are now omnipresent and have become one of the most important factors for profitability. With industrial high-speed doors from EFAFLEX, you can effectively reduce your costs: The fast opening and closing speeds of our industrial high-speed doors ensure that little energy is lost to the outside or between two rooms. In addition, we are the first manufacturer of industrial high-speed doors to offer the EFA-SST® with thermally separated EFA-THERM® insulation laths as standard. These considerably improve thermal insulation and thus also ensure lower energy consumption.

CUSTOM DOOR LEAF DESIGN

In addition to the standard aluminium-coloured coating, we are also able to paint the door's laths and steel parts in almost any RAL colour on request. This ensures that the doors can be perfectly matched to the architecture and any façade to blend in perfectly with the appearance of your company premises.

HIGH-END SAFETY TECHNOLOGY

As the world's leading manufacturer of high-speed doors, it is our aspiration to also be pioneers in the field of safety: All EFAFLEX products meet the highest standards and protect people, goods and the door itself. It is not only our industrial doors that impress with their state-of-the-art safety technology, but also the associated systems: EFA-SCAN®, for example, is the world's first laser scanner for use on doors, which is a reliable activator and safety system in one.



Optimum thermal insulation and low energy consumption with EFA-THERM® insulation laths.



Less wear thanks to the contactless curtain winding of the EFAFLEX spiral.



EFA-SST® EFFICIENT AT A GLANCE:

- Slim frame for cramped installation locations
- Chain drive ensures minimal maintenance costs
- Resistance Class 2 in accordance with DIN/TS 18194:2020 – RC 2
- Opening and closing speed up to 0.5 m/s
- Up to 150,000 operating cycles p.a.
- Max. sizes
w=4,000 mm, h=5,130 mm
- Tested and certified by ift Rosenheim

The tailored safety solution.

EFA-SST® Efficient

Cramped installation situations require a custom-fit solution which can be integrated into the on-site conditions. With the EFA- SST® Efficient high-speed spiral door, EFAFLEX offers a compact and springless door which can also be positioned in locations with confined installation space. The scope of application for the EFA-SST® Efficient ranges from indoor use to use as a secure hall door. With an on-site canopy, the high-speed door can also be installed outdoors.

SPACE-SAVING DESIGN

Thanks to the heavy-duty chain drive, the EFA-SST® Efficient does not require spring-based weight balancing. This not only saves space, but also costs for maintenance and service. Furthermore, the EFAFLEX high-speed spiral door can be used in many situations due to the compact dimensions of the door frame. Thanks to the highly insulated door leaf, it is also suitable for both indoor and outdoor use.

GUARANTEED LONGEVITY

The door leaf of the EFA-SST® Efficient consists of individual laths which are connected by a hinge chain. When the industrial door is opened or closed, the rollers attached to the hinge chain are guided through the vertical and spiral-shaped door leaf guides. This results in very low noise levels. In addition, there is only minimal wear – and none at all on the door leaf itself. This ensures a long service life for the door system.



The chain drive saves space and reduces maintenance work.



Low noise levels and minimal wear thanks to attached rollers on the hinge chain.

INNOVATIVE SAFETY

The EFA-SST® Efficient is certified according to DIN/TS 18194:2020 for resistance Class 2 and extends the EFAPROTECT® series. The innovative all-rounder ensures maximum safety as well as security without interfering with ongoing processes.



The fastest parking garage door in the world.

EFA-SST® PS

The EFA-SST® PS is a space-saving door specially developed for car park and garage systems and can be optimally installed even with minimal space in the lintel or side case area. In addition, it also features the typical properties of every EFAFLEX high-speed door: safe, reliable and incomparably fast.

RELIABLE PROPERTY PROTECTION

The EFA-SST® PS is a secure building lock-up door that opens within fractions of a second and closes immediately after a vehicle has passed through. This prevents unwanted people from accessing the parking area and unauthorised vehicles from entering the building. These stable and fast doors help to make the entrance and exit areas of (underground) car parks safer – for hotels, banks, agencies and other public institutions in particular.

SAFETY FIRST

Safety is more than just an occupational health and safety requirement. Safety is an integral part of the EFAFLEX corporate philosophy. We implement this claim uncompromisingly in our products. That's why the EFA-SST® PS has a contact strip on the end rail as well as an additional safety light barrier at the door closing level as a standard. You may also combine it with the TÜV-tested EFA-TLG®, which enables early, contactless detection of objects. This stops the closing process early when an obstacle is detected.

GUARANTEED LONGEVITY

While common car park doors are assumed to undergo approx. five opening cycles a day, the EFA-SST® PS is designed for 200,000 opening cycles a year. The durability and resilience of our doors are therefore unique on the market. Due to the slender laths, the car park door is also extremely solidly constructed and guarantees a higher wind load capacity than any other high-speed door.

EFA-SST® PS AT A GLANCE:

- Space-saving construction
- Opening speed up to 1.8 m/s
- Closing speed up to 1.0 m/s
- Highest wind load capacity
- Top safety devices
- Optionally with EFA-VENT® ventilation laths
- Up to 200,000 operating cycles p.a.
- Standard sizes up to
w=6,100 mm, h=4,000 mm



SMART CONTROL WITH COMFORT FACTOR

Manually operated car park doors are long gone. The EFA-SST® PS can be opened and closed fully electronically in various ways. Combine remote control, traffic light systems and barrier systems to create improved traffic flow in your car park building.

EFA-SST® ISO-60 AT A GLANCE:

- Max. heat insulation with EFA-THERM® laths
- U value up to 0.8 W/m²K
- 60 mm thick door leaf
- Opening speed up to 2.5 m/s
- Closing speed up to 1.0 m/s
- Up to 250,000 operating cycles p.a.
- Standard sizes up to w=6,000 mm, h=6,000 mm

The lock-up door for thermo-regulated zones.

EFA-SST® ISO-60

Doors in cooled spaces must withstand extremely high loads. Top quality and perfect workmanship are paramount for ensuring that all components are absolutely resistant to cold and humidity. EFA-SST® ISO-60 is the ideal lock-up door for frequent openings with high requirements for insulation, as is the case in cooling rooms, for example. The EFA-SST® ISO-60 combines two door technologies to create an innovative solution: the spiral and the highly insulating laths. In addition, high-quality seals prevent air and heat from passing through.



Thermally separated EFA-THERM® insulation laths with a double rubber seal guarantee perfect thermal insulation.

CONSTANT REFRIGERATION OF FOOD & PERFECT SEALING

The EFA-SST® ISO-60 is used wherever cool temperatures have to be maintained, for example in the field of airline catering: to ensure consistent quality of the meals served, constant and precise cooling is necessary. Doors in particular represent a sensitive transition between two temperature zones. When closed, the double-walled and thermally separated insulation lath of the EFA-SST® ISO-60 with a double rubber seal provides the necessary insulation. Because of how frequently the goods are moved, doors used in airline catering have to complete a correspondingly large number of opening and closing cycles. The high speeds of the EFAFLEX high-speed doors prevent excessive heat transfer.

PERFECT HEAT INSULATION

The standard 60 millimetre thick, thermally separated EFA-THERM® insulation laths guarantee even better thermal insulation than ever before. Specially developed details ensure excellent vertical and horizontal sealing of the EFA-SST® ISO-60: thermally separated aluminium profiles with low-wear seals provide vertical insulation against the door frame. The horizontal space at the connection between the building and the door leaf is closed by an active lintel seal made of aluminium. Both seals can be equipped with optional heating bands for use with large temperature differences and/or high humidity.

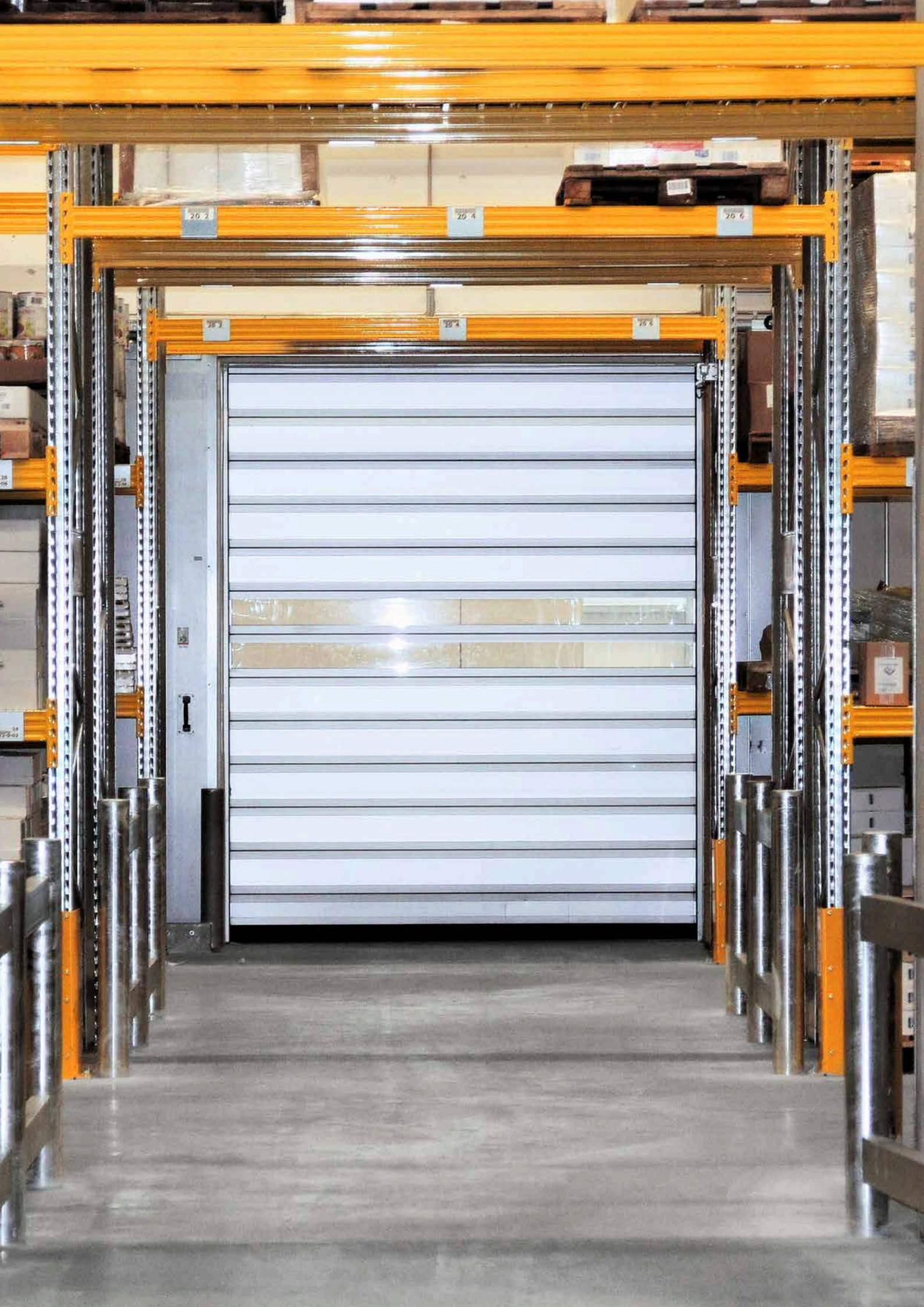



EFA-SST® TK-100
AT A GLANCE:

- Optimal single door solution
- Air permeability class 5 according to DIN EN 12426
- Frames and laths thermally separated
- Almost hermetically sealed
- Opening speed up to 2.0 m/s
- Closing speed up to 0.5 m/s
- U value up to 0.62 W/m²K
- Up to 200,000 operating cycles p.a.
- Standard sizes up to w=4,500 mm, h=6,000 mm

The specialist door for minus degrees.

EFA-SST® TK-100

The EFA-SST® TK-100 high-speed spiral door is the first true single-door solution for deep-freeze areas. In addition to the highest opening and closing speeds, it achieves the best insulation values for spiral doors and thus represents a high-quality solution for every deep-freeze room.

MINIMAL AIR EXCHANGE

Our EFA-SST® TK-100 achieves air permeability class 5 according to DIN EN 12426. The door thus guarantees minimum air exchange and is the perfect solution for inerted areas.

ENERGY-EFFICIENT FROST PROTECTION

In order to withstand frost, the EFA-SST® TK-100 is equipped with contact surface heaters that are integrated in the surrounding sealing profiles and in the contact strip profile. These heat the contact surfaces of the seals against the door leaf and the floor. As a result, an EFAFLEX deep-freeze high-speed door saves its users up to 50 percent in heating costs compared to other door solutions. The result of this unique design are U values as low as 0.62 W/m²K and operational temperatures between plus 30 °C and minus 30 °C.

PERFECT HEAT INSULATION

The EFA-SST® TK-100 impresses with its innovative door design: the door has a circumferential profile seal and a dynamic door leaf guide, which is mounted on the door frames and the spiral support so that it can be moved. As a result, the active guide rail mechanism (EFA-AFM®) moves the door leaf towards the door frame when the door is closed and, in combination with the profile seal, closes the door to near-hermetic sealing. Compared to other door designs, the installation level for doors of the EFA-SST® TK-100 series is always on the outer, i.e. the warm side, in order to be protected from cold-related wear and tear. The 100 millimetre thick, thermally separated EFA-THERM® insulation laths used as standard in the EFA-SST® TK-100 guarantee even better thermal insulation than ever before.

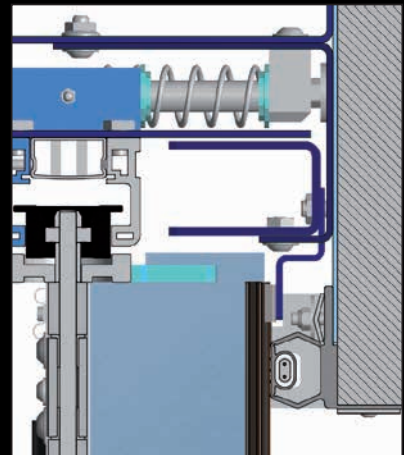

AFM system closed:
The door is sealed to near-hermetic conditions.

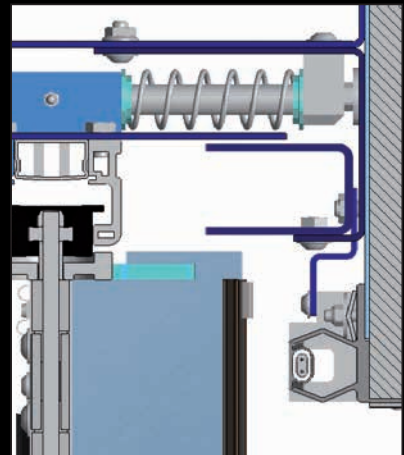

AFM system open:
The door leaf is in motion.

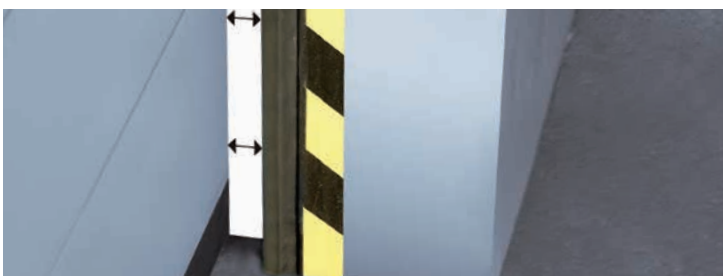

The active guide rail mechanism EFA-AFM® provides for near-hermetic door sealing.

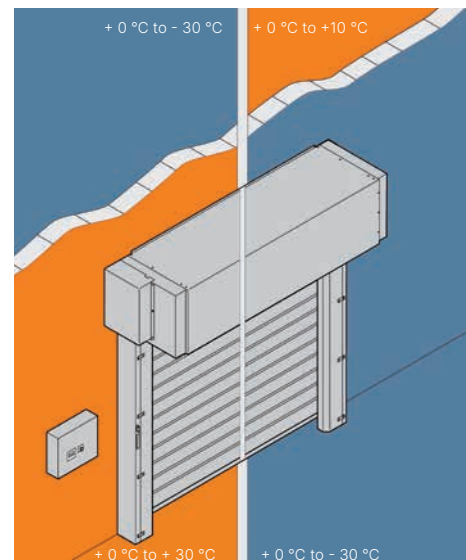

The integrated contact surface heating allows for operating temperatures between plus 30 °C and minus 30 °C.

EFA-STT® AT A GLANCE:

- The door leaf consists at 70% of crystal clear acrylic glass
- Opening speed up to 3.0 m/s
- Closing speed up to 1.0 m/s
- Highest wind load capacity
- Top safety devices
- Up to 200,000 operating cycles p. a.
- Also available in low-header design
- Standard sizes up to w=8,000 mm, h=7,800 mm

The transparent turbo door.

EFA-STT®

Thanks to laths made of crystal-clear acrylic glass, the door leaf of the EFA-STT® is over 70 percent transparent, which makes it a unique high-speed door worldwide: robust and yet almost completely transparent. The ability to see clearly through the door offers critical advantages at all passageways in your company which are passed through from two directions: Accidents are prevented and smooth transport operations are guaranteed.

NATURAL INCIDENCE OF LIGHT

The transparent laths of the EFA-STT® provide sufficient light and brightness. This makes work easier in air locks, such as those used in the automotive industry. In addition, transparent laths ensure an unobstructed view with open lines of sight between the rooms.

UNIVERSAL USE

Due to features such as the modern, transparent appearance, the fast opening speed and sizes of up to 8,000 × 7,800 millimetres, the EFA-STT® is suitable for a wide range of applications. In addition, you can customise the laths and thus adapt the door to the desired application. All transparent sections of the EFA-STT® are made of PVC-free acrylic glass as standard. Upon request, any desired combinations of grey and transparent laths can also be supplied.

HIGH PERFORMANCE FOR CONVEYOR TECHNOLOGY

Due to the constant movement of goods, doors in conveyor systems have to withstand a very high number of load cycles. This is where the EFA-STT® truly shines, thanks to its enormous load capacity! In addition to the usual quality and speed of EFAFLEX high-speed spiral doors, the EFA-STT® also stands out with its highly transparent door leaf.



High performance for conveyor technology



Laths made of acrylic glass





The fastest vertically opening door in the world.

EFA-STR®

The high-speed turbo roll-up door EFA-STR® opens at an incredible speed of up to 4 m/s thanks to its spiral technology, making it our fastest industrial door. With the EFA-STR®, your logistic processes become faster and more efficient. The combination of a spiral door leaf support and flexible curtain ensures optimal traffic flows.

EXCELLENT DIMENSIONAL STABILITY

The door leaf of the EFA-STR® consists of several segments that can be replaced individually in the event of damage. This minimises repair costs and downtime in the event of damage. The door leaf itself is made of PVC-coated polyester fabric. Aluminium profiles reinforce the individual segments at a distance of 225 millimetres and thus provide the necessary stability. As a result, even doors of several metres in width and height are still extraordinarily robust. Due to the unique combination of flexible door leaf, reinforcing aluminium profiles and EFAFLEX spiral technology, the EFA-STR® achieves record speeds.

POWERFUL DRIVE

Speed results from power, which in this case is supplied by an innovative, electronically controlled high-speed drive. Because the motor is not started with full force, the drive elements are moved evenly and smoothly, without jerking. This gentle acceleration and the smooth slowing-down during opening and closing protect the door and guarantee a long service life. Undesired linear expansions are also eliminated, as the door leaf is moved upwards and downwards by a force-fit mechanism.

EFA-STR® AT A GLANCE:

- Opening speed up to 4.0 m/s
- Closing speed up to 1.0 m/s
- Highest wind load capacity
- Top safety devices
- Up to 250,000 operating cycles p. a.
- Standard sizes up to
w=7,000 mm, h=6,000 mm



The flexible and lightweight door leaf of the EFA-STR® is practically wear-free. It is made of fabric-reinforced PVC with aluminium outer bars.



More information on our
high-speed spiral doors:
www.efaflex.com/s-series



EFA-SST® CLASSIC
AT A GLANCE:

- Aluminium laths double-walled
- Opening speed up to 2.0 m/s
- Closing speed up to 1.0 m/s
- Highest wind load capacity
- Top safety devices
- Up to 250,000 operating cycles p.a.
- Standard sizes up to
w=8,000 mm, h=7,000 mm

The pioneer in spiral technology. **EFA-SST® Classic**

Endlessly imitated – still unrivalled. The tried and tested basic concept for high-speed spiral doors from EFAFLEX remains unbeatable! The door leaf is not wound onto a shaft but rather kept at a distance in the EFAFLEX spiral to save space.

EFA-SST® CLASSIC MEETS ALL REQUIREMENTS

The EFA-SST® Classic high-speed spiral door is an extremely fast, safe and reliable exterior door. The smooth door leaf consists of extra thick, double-walled aluminium laths and therefore has an exceptionally high strength and wind stability. Depending on how much light you want to pass through, any number of clear acrylic glass laths can be installed, with the option to choose scratch-resistant polycarbonate. An additional locking device guarantees maximum burglary protection. With a wide range of equipment variants and extensive accessories, our high-speed spiral doors are a model of contemporary door technology.

DOOR SAFETY THAT SETS STANDARDS

Spiral doors satisfy all standards: Moving parts are carefully encased to ensure the best possible access protection and effective finger protection. All doors are equipped with a weight counterbalance system as standard: A tension spring mechanism is installed in the side frames, which automatically pulls the door leaf upwards if, for example, the emergency hand lever is operated in the event of a power failure. The door closing line is protected either by a contact strip or by an optoelectronic system that is fully protected and integrated into the side frames. The EFA-TLG® generates an infrared light grid with a maximum height of 2.5 m directly in the door closing line.

VERSATILE USE

High-speed spiral doors are always an intelligent solution. Whether in the low-header version for entrance and exit doors in underground car parks, or a door made entirely of ventilation laths instead of the standard laths, the possible model variants are diverse. And if the colour is important to you, almost all RAL colours are available, e.g. your corporate colours.

ALMOST WEAR-FREE DOOR LEAF

The force is transferred via hinge straps on both sides with safely integrated rollers. The laths are each independently screwed to the hinge strip, and rubber clamping profiles connect the laths to each other to seal out wind and weather. There is therefore no transfer of forces within the door leaf. Individual laths can be quickly and easily replaced if necessary.

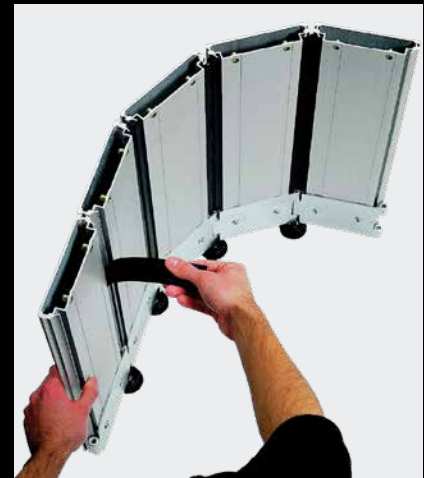

Wind- and weather-resistant door leaf thanks to rubber clamping profiles.



The EFA-VENT® ventilation laths provide for perfect air circulation.

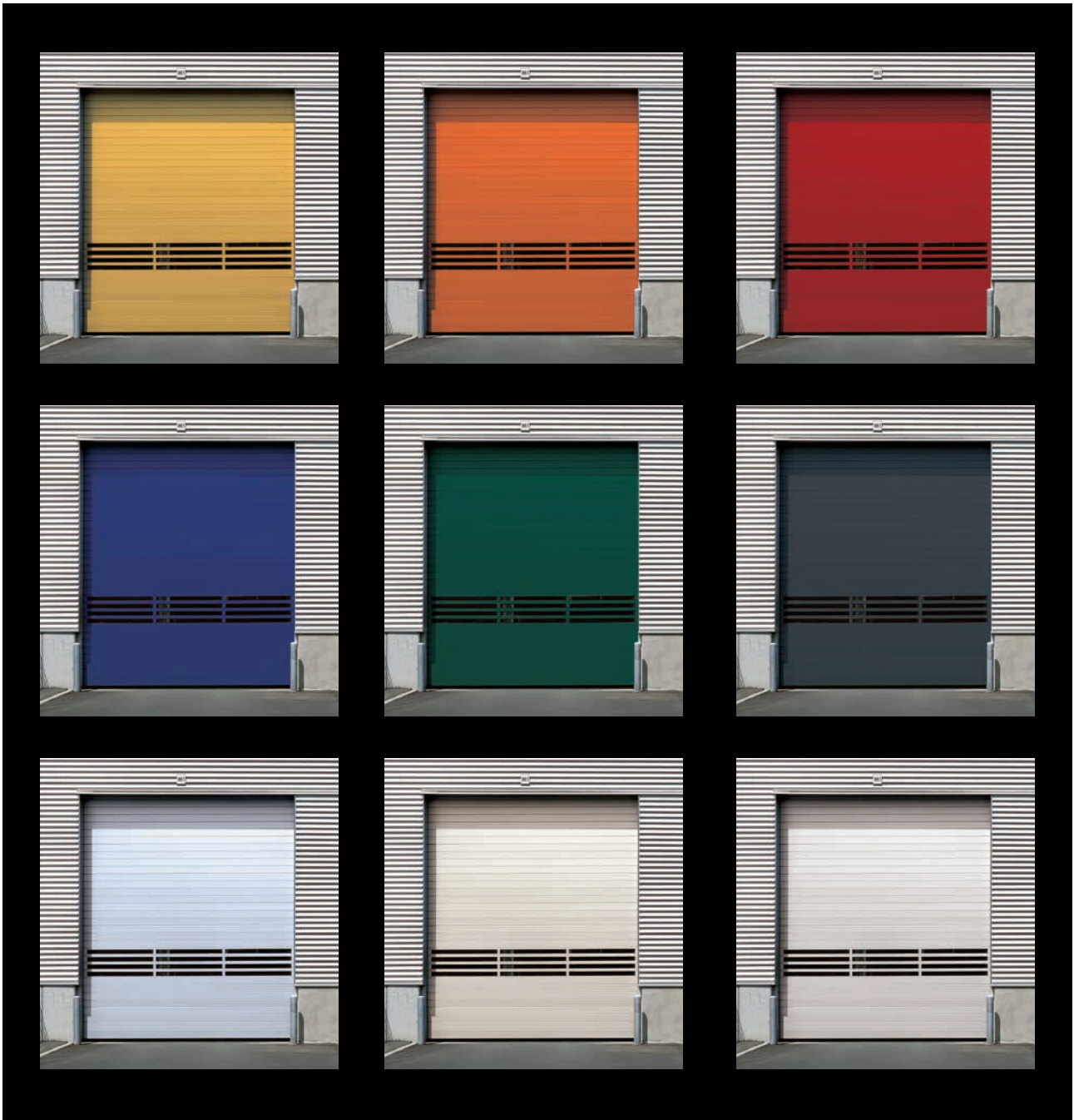

Customised configuration options.

In addition to the standard aluminium-coloured coating, we are also able to paint the door's laths and steel parts in almost any RAL colour on request. This ensures that the doors can be perfectly matched to the architecture and any facade to blend in perfectly with the appearance of your company premises.

 RAL 1021
Colza yellow

 RAL 5002
Ultramarine blue

 RAL 7035
Light grey

 RAL 2008
Bright red orange

 RAL 6005
Moss green

 RAL 9010
Pure white

 RAL 3002
Carmine red

 RAL 7016
Anthracite

 RAL 9016
Traffic white

Cutting-edge safety technology.

As the world's leading manufacturer of high-speed doors, it is our aspiration to also be pioneers in the field of safety: All EFAFLEX products meet the highest standards and protect people, goods and the door itself. It is not only our industrial doors that impress with their state-of-the-art safety technology, but also the associated systems: EFA-SCAN®, for example, is the world's first laser scanner for use on doors, which is a reliable activator and safety system in one.

EFA-SCAN® AT A GLANCE:

- Comprehensive approach surveillance
- Gapless capturing of vehicles
- Reliably ignores outside traffic
- High immunity to environmental influences (including fog)
- Performance level C according to EN 13849-1



Technical details

High-speed spiral doors

		Premium					ECO
Size		L	S	ÜS	XL	XXL	L
Application	Interior door	•	•	•	•	•	•
	Lock-up doors	•	•	•	•	•	•
Wind load max.*	According to DIN EN 12424 class	2 – 4	2 – 4	2 – 4	0 – 2	2 – 4	2 – 4
Operating forces / safe closing	According to DIN EN 13241 class	fulfilled	fulfilled	fulfilled	erfüllt	fulfilled	fulfilled
Resistance against water ingress*	According to DIN EN 13241 class	3	3	3	3	1	3
Air permeability*	According to DIN EN 13241 class	3	3	3	3	3	3
Direct airborne sound insulation R _w *	in dB according to DIN EN 717-1	24	25	26	26	26	24
U value maximum*	in W/m ² K according to DIN EN 13241	1.52	0.91	0.66	0.66	0.54	1.52
Door size (in mm)	Width W max.	4,500	6,000	8,000	10,000	10,000	4,500
	Height H max.	5,000	6,000	8,000	6,600	12,000	5,000
Maximum door leaf speed*	in m/s	2.5	1.5	1.2	1.0	0.5	1.0
Average speed, approx.*	Opening in m/s	2.0	1.2	1.0	0.8	0.5	1.0
	Closing in m/s	–	0.6	–	–	–	0.6
	Closing by door light grid EFA-TLG® in m/s	1.0	1.0	0.8	0.4	0.3	0.6
Guide of door leaf	Round Spiral	•	•	•	•	•	•
	Oval Spiral	•	•	–	–	–	•
	Low-header	–	–	–	–	–	•
Steel design	Galvanized sheet steel frame	•	•	•	•	•	•
	Stainless steel	○	○	–	–	–	○
	Powder coated in RAL colours	○	○	○	○	○	○
Door leaf	EFA-THERM® laths insulated/painted	•	•	•	•	•	•
	EFA-CLEAR® Vision laths double-walled, thermally separated	○	○	○	○	○	○
	EFA-CLEAR® Vision laths single-walled	○	○	–	–	–	○
	EFA-VENT® Ventilation laths	○	○	–	–	–	○
	EFA-ALUX® Aluminium laths	–	–	–	–	–	–
	Colour according to RAL (without vision panel)	○	○	○	○	○	○
Fire class	Building Material class DIN 4102	B2	B2	B2	B2	B2	B2
Weight balancing by		Spring	Spring	Spring	Feder	Spring	Spring
Designed for approx ... operating cycles per year		250,000	250,000	250,000	150,000	100,000	200,000
Drive	Electric motor	•	•	•	•	•	•
Control	EFA-TRONIC®	•	•	–	–	○	•
	EFA-TRONIC® Light	–	–	–	–	–	–
	EFA-TRONIC® Professional	○	○	•	•	•	○
	Main switch and foil keypad	•	•	•	•	•	•
Lead	Electricity connection 230 V/50 Hz	•	•	•	•	–	•
	Electricity connection 400 V/50 Hz	○	○	○	○	•	○
	Circuit breaker	16 A (K)	16 A (K)	16 A (K)	16 A (K)	16 A (K)	16 A (K)
Manual locking		•	•	•	•	•	○
Emergency operation	Automatic after manual activation	•	•	•	•	•	•
Safety Devices	EFA-TLG® door light grid in door closing line	•	•	•	•	•	○
	Contact edge	○	○	–	–	–	•
	Light barrier	○	○	–	–	–	•
	Approach area monitoring	○	○	○	○	○	○
	Light grid, external	○	○	○	○	○	○
Safety system including activator	EFA-SCAN® frame/bollard	○/○	○/○	○/○	○/○	○/○	○/○
	LZR®-WIDESCAN	○	○	○	○	○	○

• Standard, ○ upon request, – Not available, npd = No Performance Determined *Depending on door leaf, guide of door leaf and door size, we reserve the right to make technical changes

S Series

EFA-SST®										
	Basic			Classic				PS		
S	L	L	L	S	ÜS	L-N	S-N	PS-L	PS-N	PS-S
•	•	•	•	•	•	•	•	•	•	•
•	•	•	•	•	•	•	•	•	•	•
2-4	2-4	2-4	2-4	4	2-4	2-4	4	4	4	2
fulfilled	fulfilled	fulfilled	fulfilled	fulfilled	fulfilled	fulfilled	fulfilled	fulfilled	fulfilled	fulfilled
3	3	2	0	0	0	npd	npd	2	-	2
3	3	0	2	2	2	npd	npd	1	-	1
25	24	20	23	25	25	23	25	23	23	23
0.91	1.52	1.67	5.8	5.6	5.6	5.8	5.7	6.5	6.6	6.5
6,000	4,500	4,500	4,000	6,000	8,000	4,000	6,000	4,000	4,000	6,100
6,000	5,000	5,000	5,000	7,000	7,000	4,000	5,000	4,000	4,000	4,000
0.9	0.5	0.5	2.0	2.0	1.5	1.5	1.5	2.0	1.5	1.5
0.9	0.5	0.5	1.5	1.2	1.0	-	-	1.8	-	1.2
0.6	0.5	0.5	0.75	0.6	0.6	-	-	0.5	-	0.5
0.6	-	-	1.0	1.0	1.0	-	-	1.0	-	1.0
•	•	•	•	•	•	-	-	•	-	•
•	•	-	•	•	•	-	-	-	-	-
•	-	-	-	-	-	•	•	-	•	-
•	•	•	•	•	•	•	•	•	•	•
o	o	-	o	o	o	o	o	o	o	o
o	o	o	o	o	o	o	o	o	o	o
•	•	•	-	-	-	-	-	-	-	-
o	o	o	-	-	-	-	-	-	-	-
o	o	o	o	o	o	o	o	o	o	o
o	o	o	o	o	o	o	o	o	o	o
-	-	-	•	•	•	o	o	•	o	•
o	o	o	o	o	o	o	o	o	-	o
B2	B2	B2	B2	B2	B2	B2	B2	B2	B2	B2
Spring	Spring	Spring	Spring	Spring	Spring	Spring	Spring	Spring	Spring	Spring
200,000	100,000	100,000	250,000	250,000	250,000	150,000	150,000	200,000	200,000	200,000
•	•	•	•	•	•	•	•	•	•	•
•	o	o	•	•	-	•	•	•	•	•
-	•	•	-	-	-	-	-	-	-	-
o	o	o	o	o	•	o	o	o	o	o
•	•	o	•	•	•	•	•	•	•	•
•	•	•	•	•	•	•	•	•	•	•
o	-	-	o	o	o	o	o	o	o	o
16 A (K)	16 A (K)	16 A (K)	16 A (K)	16 A (K)	16 A (K)	16 A (K)	16 A (K)	16 A (K)	16 A (K)	16 A (K)
o	o	o	o	o	o	o	o	o	o	o
•	•	•	•	•	•	•	•	•	•	•
*	-	-	o	*	*	o	*	o	o	o
*	•	•	•	*	*	•	*	•	•	•
*	•	•	•	*	*	•	*	•	•	•
o	o	o	o	o	o	o	o	o	o	o
o	o	-	o	o	o	o	o	o	o	o
o/o	-	-	-/o	-/o	-/o	o	o	-/o	o	o/o
o	o	o	o	o	o	o	o	o	o	o

Technical alterations!

Technical details

High-speed spiral doors

		S Series			
		EFA-STT®			
Size		L	S	ÜS	L-N
Application	Interior door	●	●	●	●
	Lock-up doors	●	●	●	●
Wind load max.*	According to DIN EN 12424 class	3 – 4	2 – 4	2 – 4	3 – 4
Operating forces / safe closing	According to DIN EN 13241 class	fulfilled	fulfilled	fulfilled	fulfilled
Resistance against water ingress*	According to DIN EN 13241 class	0	0	0	0
Air permeability*	According to DIN EN 13241 class	2	2	2	0
Direct airborne sound insulation R _w *	in dB according to DIN EN 717-1	20	20	20	20
U value maximum*	in W/m ² K according to DIN EN 13241	6.5	6.37	6.28	6.5
Door size (in mm)	Width W max.	4,000	6,000	8,000	4,000
	Height H max.	5,000	6,000	7,800	5,000
Maximum door leaf speed*	in m/s	3.0	2.8	2.0	1.8
Average speed, approx.*	Opening in m/s	2.5	2.2	1.8	–
	Closing in m/s	0.75	0.6	0.6	–
	Closing by door light grid EFA-TLG® in m/s	1.0	0.6	0.6	–
Guide of door leaf	Round Spiral	●	●	●	–
	Low-header	–	–	–	●
Steel design	Galvanized sheet steel frame	●	●	●	●
	Stainless steel	○	○	–	○
	Powder coated in RAL colours	○	○	○	○
Door leaf	EFA-CLEAR® Vision laths single-walled	●	●	●	●
	EFA-VENT® Ventilation laths	○	○	○	○
	EFA-ALUX® Aluminium laths	–	–	–	○
	Vision panel single-walled / double-walled	●/–	●/–	●/–	●/–
	Non transparent infill single-walled / doublewalled	○/–	○/–	○/–	○/–
	Colour according to RAL (without vision panel)	○	○	○	○
Fire class	Building Material class DIN 4102	B2	B2	B2	B2
Weight balancing by		Spring	Spring	Spring	Spring
Designed for approx ... operating cycles per year		200,000	200,000	200,000	120,000
Drive	Electric motor	●	●	●	●
Control	EFA-TRONIC®	●	●	–	●
	EFA-TRONIC® Professional	○	○	●	○
	Main switch and foil keypad	●	●	●	●
Lead	Electricity connection 230 V/50 Hz	●	●	●	●
	Circuit breaker	16 A (K)	16 A (K)	16 A (K)	16 A (K)
Manual locking		○	○	○	○
Emergency operation	Automatic after manual activation	●	●	●	●
Safety Devices	EFA-TLG® door light grid in door closing line	○	*	*	○
	Contact edge	●	*	*	●
	Light barrier	●	*	*	●
	Approach area monitoring	○	○	○	○
	Light grid, external	○	○	○	○
Safety system including activator	EFA-SCAN® frame/bollard	○/○	○/○	○/○	○/○
	LZR®-WIDESCAN	○	○	○	○

● Standard, ○ upon request, – Not available,

*Depending on door leaf, guide of door leaf and door size, we reserve the right to make technical alterations!

		S Series			
		EFA-STR®			
	Size	L	S	S-N	L-N
Application	Interior door	●	●	●	●
	Lock-up doors	○	○	○	○
Wind load max.*	According to DIN EN 12424 class	2 – 3	2 – 3	2 – 3	2 – 3
Operating forces / safe closing	According to DIN EN 13241 class	fulfilled	fulfilled	fulfilled	fulfilled
Resistance against water ingress*	According to DIN EN 13241 class	0	0	npd	npd
Air permeability*	According to DIN EN 13241 class	1	1	npd	npd
Direct airborne sound insulation R _w *	in dB according to DIN EN 717-1	12	12	12	12
U value maximum*	in W/m ² K according to DIN EN 13241	6.1	5.95	6.0	6.1
Door size (in mm)	Width W max.	4,000	7,000	7,000	4,000
	Height H max.	5,000	6,000	5,000	5,000
Maximum door leaf speed*	in m/s	4.0	3.2	3.2	3.2
Average speed, approx.*	Opening in m/s	3.6	2.8	–	–
	Closing in m/s	0.75	0.75	–	–
	Closing by door light grid EFA-TLG® in m/s	1.0	1.0	–	–
Guide of door leaf	Round Spiral	●	●	–	–
	Low-header	–	–	●	●
Steel design	Galvanized sheet steel frame	●	●	●	●
	Stainless steel	○	○	○	○
	Powder coated in RAL colours	○	○	○	○
Door leaf	flexible fabric in different colours with/ without vison panel	○/●	○/●	○/●	○/●
Fire class	Building Material class DIN 4102	B2	B2	B2	B2
Weight balancing by		Spring	Spring	Spring	Spring
Designed for approx ... operating cycles per year		200,000	200,000	120,000	120,000
Drive	Electric motor	●	●	●	●
Control	EFA-TRONIC®	●	●	●	●
	EFA-TRONIC® Light	–	–	–	–
	EFA-TRONIC® Professional	○	○	○	○
	Main switch and foil keypad	●	●	●	●
Lead	Electricity connection 230 V/50 Hz	●	●	●	●
	Electricity connection 400 V/50 Hz	○	○	○	○
	Circuit breaker	16 A (K)	16 A (K)	16 A (K)	16 A (K)
Emergency operation	Automatic after manual activation	●	●	●	●
Safety Devices	EFA-TLG® door light grid in door closing line	○	○(*)	○(*)	○
	Contact edge	●	●	●	●
	Light barrier	●	●	●	●
	Approach area monitoring	○	○	○	○
	Light grid, external	○	○	○	○
Safety system including activator	EFA-SCAN® frame/bollard	○/○	○/○	○/○	○/○
	LZR®-WIDESCAN	○	○	○	○

● Standard, ○ upon request, – Not available, , npd = No Performance Determined, ○ (*) Standard for W > 5,000 mm,
* Depending on door leaf, guide of door leaf and door size, we reserve the right to make technical alterations!

Technical details

High-speed doors deep-freeze

		S Series				
		Premium		EFA-SST®		Inertisation
Size		ISO-L-60	ISO-60	Installation on warm side	Installation on cold side	
Application	Interior door	●	●	Lock-up-deep-freeze	Lock-up-deep-freeze	●
	Lock-up doors	●	●	–	–	●
Wind load max.*	According to DIN EN 12424 class	3 – 4	2 – 4	3	3	3
Operating forces / safe closing	According to DIN EN 13241 class	fulfilled	fulfilled	fulfilled	fulfilled	fulfilled
Resistance against water ingress*	According to DIN EN 13241 class	3	3	npd	npd	npd
Air permeability*	According to DIN EN 13241 class	3	3	5	5	5
Direct airborne sound insulation R _w *	in dB according to DIN EN 717-1	25	25	26	26	26
U value maximum*	in W/m²K according to DIN EN 13241	0.93	0.80	0.62	0.62	0.62
Door size (in mm)	Width W max.	4,500	6,000	4,000	4,000	4,500
	Height H max.	4,550	6,000	6,000	6,000	6,000
Maximum door leaf speed*	in m/s	2.5	1.5	2.0	2.0	2.0
Average speed, approx.*	Opening in m/s	2.0	1.2	2.0	2.0	2.0
	Closing in m/s	0.75	0.6	0.75	0.75	0.75
	Closing by door light grid EFA-TLG® in m/s	1.0	1.0	1.0	1.0	1.0
Guide of door leaf	Round Spiral	●	●	●	●	●
Steel design	Galvanized sheet steel frame	●	●	●	●	●
	Stainless steel	○	○	○	○	○
	Powder coated in RAL colours	○	○	○	○	○
Door leaf	EFA-THERM® laths insulated / painted	●	●	●	●	●
	EFA-CLEAR® Vision laths double-walled, thermally separated	○	○	–	–	○
	EFA-ALUX® Aluminium laths	–	–	–	–	–
	Colour according to RAL (without vision panel)	○	○	○	○	○
Fire class	Building Material class DIN 4102	B2	B2	B2	B2	B2
Weight balancing by		Spring	Spring	Spring	Spring	Spring
Designed for approx ... operating cycles per year		250,000	250,000	200,000	200,000	200,000
Drive	Electric motor	●	●	●	●	●
Control	EFA-TRONIC®	●	●	–	–	●
	EFA-TRONIC® Light	–	–	–	–	–
	EFA-TRONIC® Professional	○	○	●	●	○
	Main switch and foil keypad	●	●	●	●	●
Lead	Electricity connection 230 V/50 Hz	●	●	–	–	●
	Electricity connection 400 V/50 Hz	○	○	●	●	○
	Circuit breaker	16 A (K)	16 A (K)	25 A (K)	25 A (K)	16 A (K)
Manual locking		●	●	○	○	○
Emergency operation	Automatic after manual activation	●	●	●	●	●
Safety Devices	EFA-TLG® door light grid in door closing line	●	●	●	–	●
	Contact edge	○	○	●	●	○
	Light barrier	○	○	○	●	○
	Approach area monitoring	○	○	○	–	○
	Light grid, external	○	○	○	–	○
Safety system including activator	EFA-SCAN® frame/bollard	○/○	○/○	–	–	–
	LZR®-WIDESCAN	○	○	–	–	–

● Standard, ○ upon request, – Not available, npd = No Performance Determined,

* Depending on door leaf, guide of door leaf and door size, we reserve the right to make technical alterations!

Technical details

High-speed doors burglary protection

		EFAPROTECT Series
	Size	EFA-SST® Efficient L
Application	Interior door Lock-up doors	● ●
Wind load max.*	According to DIN EN 12424 class	2 – 4
Operating forces / safe closing	According to DIN EN 13241 class	fulfilled
Resistance against water ingress*	According to DIN EN 13241 class	2
Air permeability*	According to DIN EN 13241 class	0
Direct airborne sound insulation R _w *	in dB according to DIN EN 717-1	20
U value maximum*	in W/m ² K according to DIN EN 13241	1.7
Door size (in mm)	Width W max.	4,000
	Height H max.	5,130
Guide of door leaf	Round Spiral	●
Steel design	Galvanized sheet steel frame	●
	Powder coated in RAL colours	○
Door leaf	EFA-THERM® laths insulated/painted	●
	EFA-THERM® laths with double-walled viewing windows	○
	EFA-CLEAR® Vision laths single-walled	○
	EFA-VENT® Ventilation laths	○
	EFA-ALUX® Aluminium laths	–
Fire class	Building Material class DIN 4102	B2
Weight balancing by		Spring
Designed for approx ... operating cycles per year		150,000
Drive	Electric motor	●
Control	EFA-TRONIC®	●
	EFA-TRONIC® Professional	○
	Main switch and foil keypad	●
Lead	Electricity connection 230 V/50 Hz	–
	Electricity connection 400 V/50 Hz	●
	Circuit breaker	16 A (K)
Emergency operation	Automatic after manual activation	–
	Manual activation	●
Safety Devices	EFA-TLG® door light grid in door closing line	–
	Contact edge	●
	Light barrier	●
	Approach area monitoring	○
	Light grid, external	○
Safety system including activator	EFA-SCAN® frame/bollard	○/○
	LZR®-WIDESCAN	○

● Standard, ○ upon request, – Not available, * Depending on door leaf, guide of door leaf and door size, we reserve the right to make technical alterations!

EFAFLEX
Tor- und Sicherheitssysteme
GmbH & Co. KG
Fliederstraße 14
84079 Bruckberg / Germany
Telephone +49 8765 82-0
www.efaflex.com
info@efaflex.com

EFAFLEX® is a registered and legally
protected trademark.

Subject to technical changes. Some
diagrams depict special features.

Overall design:

www.creativconcept.de 09 | 2024

EFAFLEX 
safe high-speed doors